



## **PowerLite<sup>®</sup> Pro G5750WUNL** MULTIMEDIA PROJECTOR



### **Premium Projection Solution with Full HD, WUXGA Resolution and Precision Control.**

The Epson PowerLite Pro G5750WUNL offers the ultimate projection solution for any auditorium or boardroom, even in ambient light. It ensures amazing image quality with 4500 lumens color/white light output,<sup>1</sup> Full HD WUXGA (1920 x 1200) resolution and C<sup>2</sup>Fine™ technology. Engineered to integrate with both IP and RS-232, the G5750WUNL works with industry-leading devices, allows easy remote monitoring and control functions using Epson's Easy Management<sup>®</sup> software and is also compatible with Crestron's RoomView. The G5750WUNL features DICOM simulation mode for training and educational purposes and closed captioning decoder.

**High brightness and Full HD performance** — crystal-clear images with WUXGA resolution, C<sup>2</sup>Fine technology, 4500 lumens high color/white light output,<sup>1</sup> and up to 1500:1 contrast ratio

**Complete networkability** — wired and wireless (optional) Crestron RoomView compatible network connection, content over IP and message broadcasting

**Enhanced connectivity** — HDMI, DVI-D, VGA and multiple video/audio inputs

**Multi-screen options** — project two side-by-side images from different inputs, or up to four images from network users

**Five lens options** — interchangeable bayonet lens options, including short-throw, long-throw and rear-projection; plus horizontal/vertical lens shift for flexible setup configurations



# PowerLite® Pro G5750WUNL

MULTIMEDIA PROJECTOR

## The best-selling projectors in the world.

Epson understands business and education and has a solution no matter what your situation. Built with image quality and reliability in mind, Epson projectors enhance communication and inspire collaboration, while offering a low total cost of ownership. From long-throw projectors to ultra-short-throw and all-in-one solutions, Epson has the model made for you.



## Brilliant image quality

### 3LCD technology — for quality and color that's beyond amazing

- 3 chips for full-time, vibrant color
- 25% less electricity required per lumen of brightness when compared to 1-chip DLP projectors<sup>2</sup>
- Over 20 years of road-tested reliability built into every projector

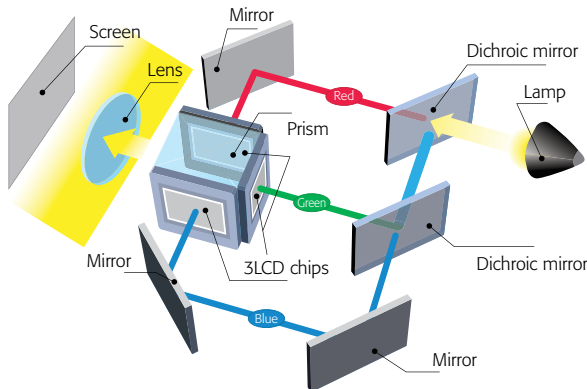

▲ 3LCD technology

### Advanced sharpness

Another feature Epson has transferred over from its industry leading home cinema projectors — advanced sharpness for video. Depending on the content, user can adjust any of the following attributes of the image depending on the content: thin line enhancement, thick line enhancement, vertical line enhancement or horizontal line enhancement.

### Amazing color light output

Rich color and detail are critical for presentations — that's why it's important to understand that color light output is an essential ingredient in achieving optimum performance. The PowerLite Pro G5750WUNL delivers 4500 lumens of color light output and 4500 lumens of white light output<sup>1</sup> for bright, vibrant colorful images.



### C<sup>2</sup>Fine™ technology delivers a higher contrast ratio

C<sup>2</sup>Fine offers smooth, uniform images with exceptional contrast for better image quality. Based on this new phase-compensation technology, light leakage is eliminated, and, when combined with auto iris, it allows for contrast ratios of up to 1500:1.



▲ With C<sup>2</sup>Fine



▲ Without C<sup>2</sup>Fine

### Enhanced connectivity

The PowerLite Pro G5750WUNL is equipped with:

- Full digital connectivity with HDMI port
- 5 BNC, 2 video/audio, 2 x VGA and RS-232 for additional flexibility

## Better Products for a Better Future®

For more information on Epson's environmental programs, go to [eco.epson.com](http://eco.epson.com)

### Eco Features

- Energy-efficient 3LCD light engine
- Designed to be recycled<sup>3</sup>
- Epson America, Inc. is a SmartWay<sup>SM</sup> Transport Partner<sup>4</sup>



# Full-featured performance

## DICOM simulation mode

DICOM (Digital Imaging and Communication in Medicine) is a standard for handling, storing, printing and transmitting medical imaging information. The projector's DICOM Simulation Mode enables users to reproduce images with an advanced grayscale level that simulates DICOM Part 14. This mode is ideal for viewing grayscale medical images, such as X-rays, for training and educational purposes.<sup>2</sup>



▲ Normal Mode

▲ DICOM Simulation Mode

## 6-axis color adjustment

For special projection material such as high-quality photographs or artwork, users can adjust the hue, saturation and brightness for six colors, RGBCMY (Red, Green, Blue, Cyan, Magenta, Yellow).

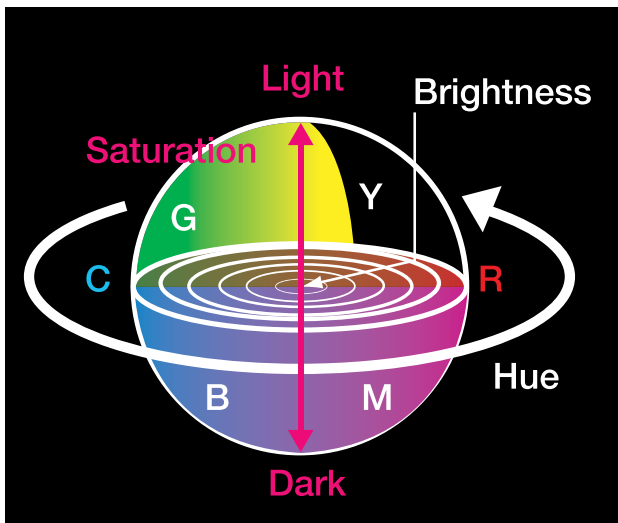

## Improved video with 3:2 and 2:2 pull-down options

3-2 pull-down creates 60 frames per second and 2-2 pull-down creates 48 frames per second from 24 frames, as shown in the chart.

3-2 pull-down: The image is smoother.

2-2 pull-down: The one frame length is the same as film. It is ideal for movies.

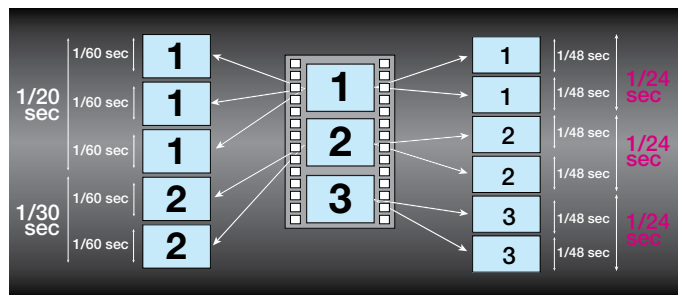

## Test patterns

The PowerLite Pro G5750WUNL also features four test patterns for precise setup, including detecting distortion, checking linearity, color reproduction and bleeding, and DICOM simulation mode.



▲ Standard

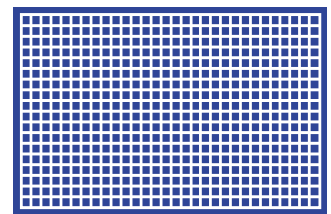

▲ Cross-Hatch



▲ Color Bars

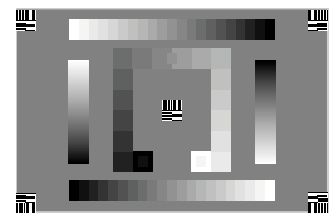

▲ Grayscale

# Advanced control, monitoring and communication

## Epson's EasyMP® monitor tool

If you are searching for a solution that gives you control over your time, Epson network projectors with Easy Management® capabilities can help. Epson networked projectors contain built-in remote access, with no licensing fees added, to utilize the Epson monitor software. These features also give you control, with the ability to troubleshoot and monitor all Epson networkable projector from any PC computer over a wired or wireless Ethernet network.

### Additional features to assist administrators/Help Desk

- Remote access and control through the network
- Remote monitoring of up to 1024 Epson networked projectors
- Simultaneously view status, including input sources, power on/off, lamp life hours and more
- Preventative maintenance features, including temperature levels and error alerts
- Schedule (filter and lamp time settings)
- E-mail notification (SMTP) to send alerts to your handheld device
- Enterprise SNMP plug-in available



## Network projection — content over IP

You can use EasyMP Network Projection to project your computer screen through the projector via a network for effective meetings, presentations and digital signage applications. You can use either wired or high-security wireless LAN connections and project the same or up to four different images on up to four projectors, or display a panoramic image.

## Full networkability

Epson networked projectors can also be accessed from your browser via an internal web page. Whether you assign a static IP address or enable DHCP, the projector becomes accessible once it's integrated in your network. The internal web page lets you control items such as network configuration, projector settings and e-mail alerts.



## Message broadcasting

This innovative feature enables you to broadcast customized images/alerts over the network for announcements or instructions. Messages can be sent to up to 1024 projectors simultaneously and will overwrite the current screen content if the projector is being used, unless this function is disabled by the presenter. If the projector is off, message broadcasting will turn the projector on and then display the message.



# Powerful content management

## Split Screen

Split Screen allows you to display content from two inputs simultaneously, side by side, on a single screen with the following features:

- Three layout options, as shown below
- Video and presentation materials displayed simultaneously
- The ability to run video on both screens



Layout Option-1: 50-50% Split Screen

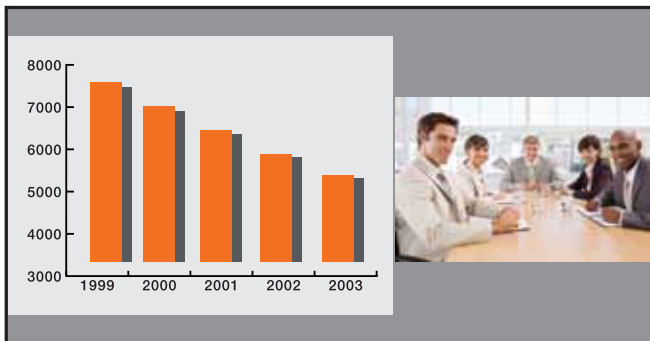

Layout Option-2: Main image on the left



Layout Option-3: Main image on the right

## Multi-PC projection

Epson Multi-PC Collaboration utility allows you to display four individual PC screens simultaneously over the network with another 12 users connected to the same projector on Standby mode. You can drag and drop participants into or out of one of the four quadrants. This feature is a great tool for meetings or classroom projects where multiple users want to present and compare their screens. You can also connect up to four remote projectors at the same time and show the same multi-screen image — another great tool for remote meeting setups.

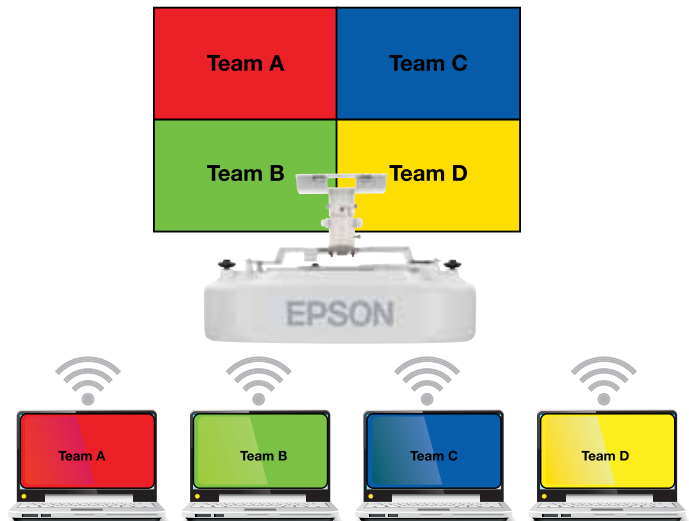

# Easy and flexible installations

## Centered lens design

With lens-to-screen alignment, the PowerLite Pro G5750WUNL makes installation easy to plan. Installers can position the ceiling mount, screen and projector independently of one another, knowing that the center of the screen will align with the lens at the center of the projector.



## Five lens options

With a 1.6x standard lens (not included), the PowerLite Pro G5750WUNL offers remarkable placement flexibility. For even greater flexibility, Epson offers a total of five lenses with varying ranges including a rear-throw lens. This allows users to choose the motorized lens most suited for their environment. A quick release lever allows for a quick, easy lens exchange.

## Off-axis, flexible installation

The Pro G5750WUNL also features a  $\pm 30$ -degree tilt operation for off-axis positioning flexibility. As a result, the G5750WUNL can be used for a wide range of applications, such as projecting on angled surfaces. Epson technology keeps the projector running without compromising performance or causing overheating.

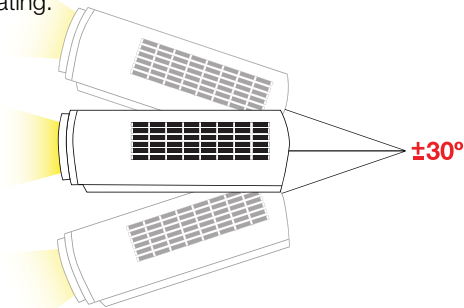

## Keystone correction

Adjusts up to  $\pm 40$  degrees vertically and  $\pm 20$  degrees horizontally to easily achieve a perfect square image.

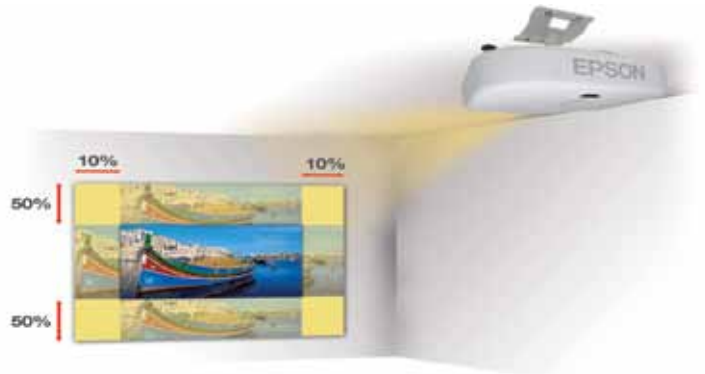

## Epson lens shift technology

In addition to added reliability and amazing color performance, Epson's industry-leading 3LCD technology enables these projectors to achieve a wide range of lens shift capabilities, allowing you to install around obstacles. This lens shift technology enables an incredible range of  $\pm 50$  percent on the vertical axis and  $\pm 10$  percent on the horizontal axis.

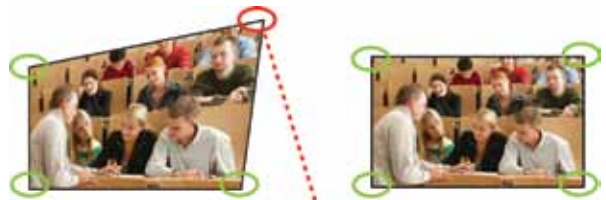

## Quick Corner®

This innovative feature allows you to move any of the four corners of an image independently at setup, using the remote control to adjust each corner for a perfectly rectangular picture. Quick Corner also makes life very easy when setting up a stacked 3D projector solution for education and entertainment. All you need to do is to project the first image and then adjust the corners of the second image to perfectly match the first one.

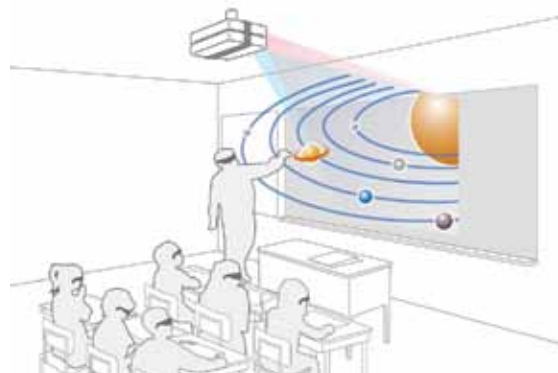

## Low cost of ownership

### Long-life lamp that's easy to replace

This high-efficiency lamp lasts up to 2,000 hours in Normal Mode and up to 3,000 hours in ECO Mode.<sup>6</sup> It can be replaced quickly and easily, without having to uninstall the projector from the ceiling.



### Long-life electrostatic air filter

This innovative filter was designed to protect the optical engine, lamp and electronics from small dust particles that can enter any projector. It has a recommended 3,000-hour filter cleaning schedule<sup>7</sup> and can capture particles as small as three microns, due in part to its pleated, expanded design.



### Built-in 7 W speaker

- For multimedia applications — convenient built-in speaker

### Built-in closed captioning



- Accommodates those with hearing impairments
- Delivers important content when audio broadcasting is not preferred
- Helps save money — no need to pay for an additional decoder and its installation
- Effective and easy to use — easily enabled or disabled through the projector remote or menu



# PowerLite® Pro G5750WUNL

## Multimedia Projector

Product Name	Product Code	UPC
PowerLite Pro G5750WUNL	V11H345920	0 10343 87870 9
Genuine Epson Lamp	V13H010L63	0 10343 88123 5
Replacement Air Filter	V13H134A17	0 10343 86897 7

### Specifications

#### Projection System

High-aperture Epson 3LCD, 3-chip technology

#### Projection Method

Front/rear/ceiling mount

#### Driving Method

Epson Poly-silicon TFT Active Matrix

#### Pixel Number

2,304,000 pixel x 3 LCDs (1920 x 1200)

#### Native Resolution

1920 x 1200 (WUXGA)

#### Resize

640 x 480, 800 x 600, 1280 x 1024,

1400 x 1050, 1600 x 1200

#### Aspect Ratio

Supports 4:3, 16:9, 16:10

#### Pixel Arrangement

Cross stripe

#### Color Light Output<sup>1</sup>

4500 lumens

#### White Light Output<sup>1</sup>

4500 lumens (ISO 21118 standard)

#### Contrast Ratio (High Brightness, Dynamic Mode)

1500:1

#### Brightness Uniformity (typical)

88%

#### Color Reproduction

16.7 million colors

#### Size (projected distance)

30" – 300"

#### Lens Shift

Vertical: ±58 degrees

Horizontal: ±9 degrees

#### Keystone Correction

Vertical: ±30 degrees

Horizontal: ±20 degrees

#### Lamp Type

275 W UHE

#### Lamp Life<sup>4</sup>

2000 hours (Normal Mode)

3000 hours (ECO Mode)

### Effective Scanning Frequency Range

#### Pixel Clock

13.5 MHz – 162 MHz (up to UXGA 60 Hz)

#### Horizontal

15 kHz – 92 kHz

#### Vertical

50 Hz – 85 Hz

### Video I/O

#### Display Performance

NTSC: 560 line

PAL: 560 line

(depends on observation of the multi-burst pattern)

#### Input Signal

NTSC/NTSC4.43/PAL/M-PAL/N-PAL/

PAL60/SECAM/480i/576i/480p/576p/720p/

1080i/1080p

Pixel works: video chip

3D Y/C separation, noise reduction

motion compensated

Interlace-Progressive conversion

(2 – 2, 3 – 2 film detection)

#### Interfaces

HDMI x 1

DVI-D x 1

Computer: D-sub 15pin x 1

Video-1: 5-BNC x 1

Video-2: RCA x 1

Composite video: BNC x 1

S-Video x 1

Audio-in: Mini stereo x 3

Audio-in: RCA (L&R) x 1

Network: RJ-45 x 1, 100 Mbps

USB Type-A x 1

Serial: RS-232c

Hardwire Remote jack x 1

Monitor-Out: D-sub 15pin x 1

### Projection Lens

#### Type

Manual focus/zoom

#### F-number

1.65 – 2.55

#### Focal Length

21.28 mm – 37.94 mm

#### Zoom Ratio

Optical zoom 1.0 – 1.8

#### Throw Ratio Range

1.30 – 2.36

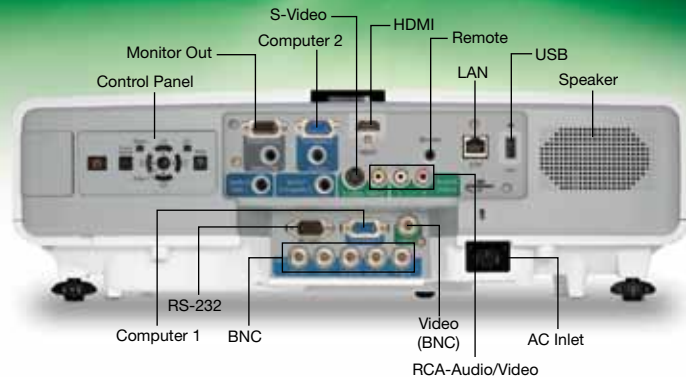

### Other Features

#### Operating Temperature

32° to 104° F (0° to 40° C)

#### Power Supply Voltage

100 – 240 V ±10%, 50/60 Hz AC

#### Power Consumption

477 W (Normal Mode)

394 W (ECO Mode)

10 W Standby (Communication on)

0.38 W Standby (Communication off)

#### Fan Noise

39 dB (Normal Mode)

33 dB (ECO Mode)

#### Security

Security cable hole, lens lock,

Kensington® lock provision

### Dimensions (W x D x H)

#### Including Feet (with standard lens)

18.5" x 12.26" x 5.96"

#### Excluding Feet, Lens

18.5" x 12.26" x 5.31"

Weight 15 lb

### Remote Control

#### Features

Power, source search selection, computer, video, A/V mute, freeze, user ID, auto, aspect, color mode, num, page up and down, E-zoom, volume, help, menu, enter, esc and pointer functions

#### Operating Angle

Right/left:

Front: ± 60 degrees

Rear: ± 30 degrees

Upper/lower:

Front: ± 20 degrees

Rear: +10 to +45 degrees

Operating Distance

49 ft

### Support

#### The Epson Connection<sup>SM</sup>

Pre-sales support U.S. and Canada

800-463-7766

Internet website [www.epson.com](http://www.epson.com)

#### Service Programs

Two-year limited warranty, Epson Road Service program, Epson PrivateLine® dedicated toll-free support (U.S. and Canada only) and 90-day limited lamp warranty

#### What's In The Box

PowerLite Pro G5750WUNL projector, power cable, computer cable (VGA), projector remote control with batteries, user manual CD, EasyMP software CD, Quick Setup Sheet, PrivateLine support card, registration card, password protection sticker and lens lock screw

### Accessory Part Numbers

Genuine Epson lamp	V13H010L62
Replacement air filter	V13H134A17
Wireless LAN 802.11 module	V12H306P11
Standard lens	V12H004S05
Long throw zoom	V12H004L06
Middle throw 1 zoom	V12H004M04
Middle throw 2 zoom	V12H004M05
Rear projector wide fixed	V12H004R03
Replacement remote control	1485872
Advanced projector ceiling mount with precision gear	ELPMBPRG
Adjustable suspended ceiling channel kit	ELPMBP01
False ceiling plate kit	ELPMBP02
Structural round ceiling plate	ELPMBP03
Adjustable extension column (pipe) 8" – 11"	ELPMB01
Kensington security lock	ELPSL01
50-inch portable screen (4:3 aspect ratio)	ELPSC06
60-inch portable pop-up screen (4:3 aspect ratio)	ELPSC07
80-inch portable pop-up screen (4:3 aspect ratio)	ELPSC08
Duet™ portable projector screen (4:3/16:9 combination)	ELPSC80
Component to VGA video cable	ELPKC19
S-video cable	ELPSV01
Distribution amplifier	ELPDA01
Remote control (ELPST16)	V12H007T16
Image presentation camera (ELPDC05)	V12H162020

### Packaging Specifications

#### PowerLite Pro G5750WUNL

Dimensions 22.4" x 21.6" x 11.1" (W x D x H)

Weight 22.1 lb

#### Genuine Epson Lamp

Dimensions 6.3" x 5.6" x 5.6" (W x D x H)

Weight 0.8 lb

Master Carton

Dimensions 28.4" x 13.1" x 6.8" (W x D x H)

Weight 9 lb

Units Per Master Carton 10

#### Replacement Air Filter

Dimensions 11.3" x 3.7" x 1.9" (W x D x H)

Weight 0.21 lb

Master Carton

Dimensions 19.2" x 11.8" x 4.8" (W x D x H)

Weight 3.09 lb

Units Per Master Carton 10

<sup>1</sup> White and color light output will vary depending on mode selected. White light output measured using ISO 21118 standard.

<sup>2</sup> Data source: ProjectorCentral.com Jan 2010. Average of 910 models for which the manufacturers provided lumens and total power data, all resolutions and brightness levels.

<sup>3</sup> See our website for convenient and reasonable recycling options at [www.epson.com/recycle](http://www.epson.com/recycle)

<sup>4</sup> SmartWay is an innovative partnership of the U.S. Environmental Protection Agency that reduces greenhouse gases and other air pollutants and improves fuel efficiency.

<sup>5</sup> This projector does not meet the DICOM standard Part 14 and should not be used as a medical diagnostic device.

<sup>6</sup> Lamp life will vary depending upon mode selected, environmental conditions and usage. Lamp brightness decreases over time.

<sup>7</sup> Recommended based on normal room conditions. Cleaning requirements may vary depending on use, environment and other conditions. Cleaning intervals may be adjusted to accommodate the environment in which the projector is used.

Available at: NETWORK Spectrum®

Call: 301-733-0657

Email: [sales@networkspectrum.com](mailto:sales@networkspectrum.com)

Other products available at:

[www.networkspectrum.com/gsaschedule/](http://www.networkspectrum.com/gsaschedule/)